

EL TESORO DE ESTEBAN Y SUS AMIGOS

Libro inicial de lectoescritura



Autor: William Javier Jurado Pérez

Ilustrador: Iván Andrés Casas Delgado

El tesoro de Esteban y sus amigos.

Silabario



**Nombra y asocia
cada imagen con
su vocal:**

Aa

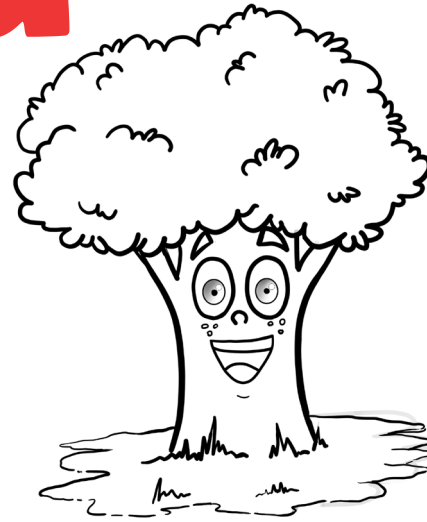

árbol

Ee



elefante

Ii



isla

Oo



oso

Uu

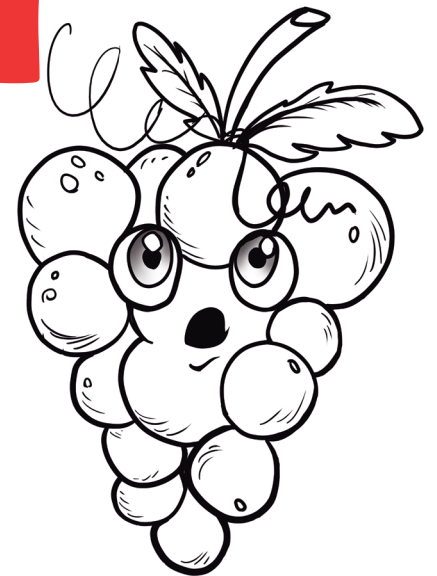

uvas

Lee y asocia las
sílabas con la
imagen indicada
de la letra

M - m

ma



mamá

mi



mimo

mu



muñeca

me

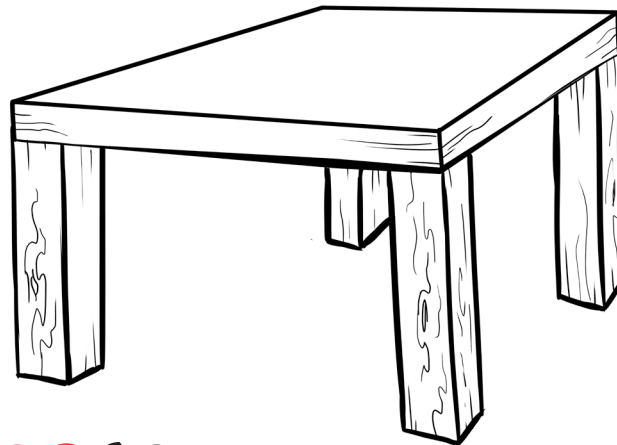

mesa

mo



momia

Lee y asocia las
sílabas con la
imagen indicada
de la letra

P - p

pa

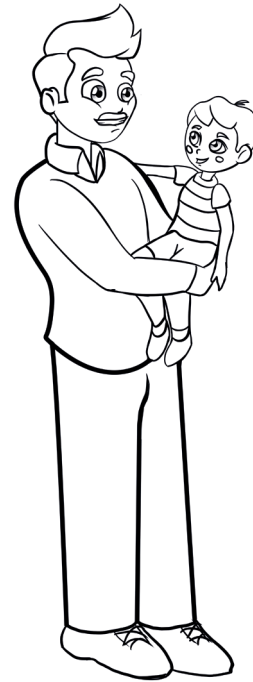

papá

po



pollo

pe



perro

pu

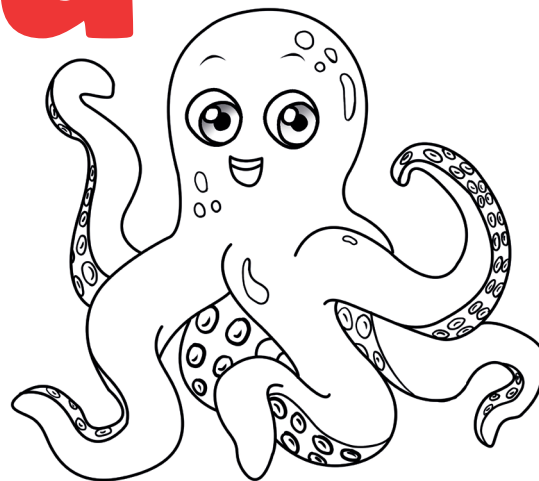

pulpo

pi

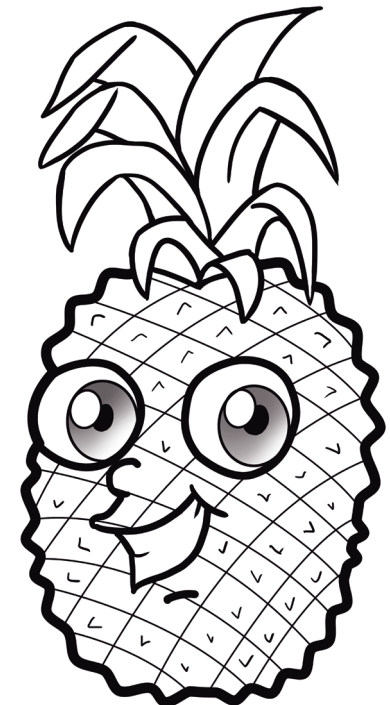

piña

Lee y asocia las
sílabas con la
imagen indicada
de la letra

S - s

su



súperheroe

se

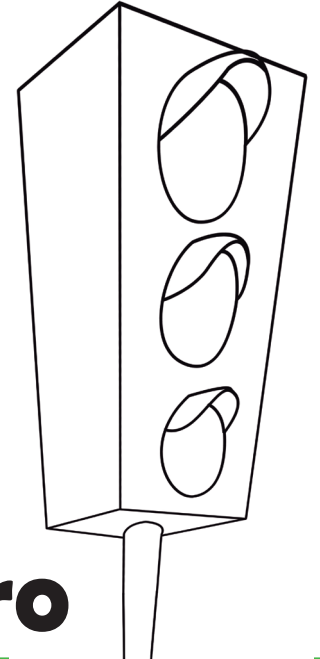

semáforo

sa



sapo

si

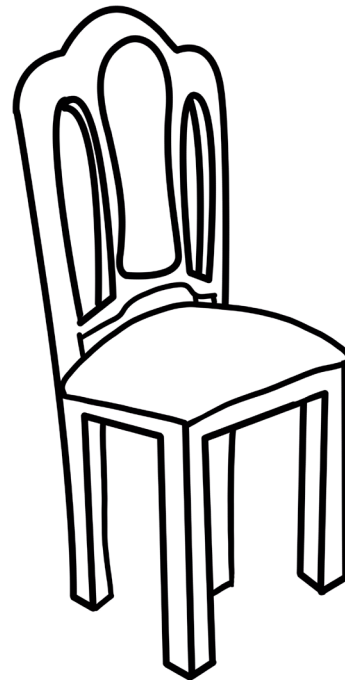

silla

so

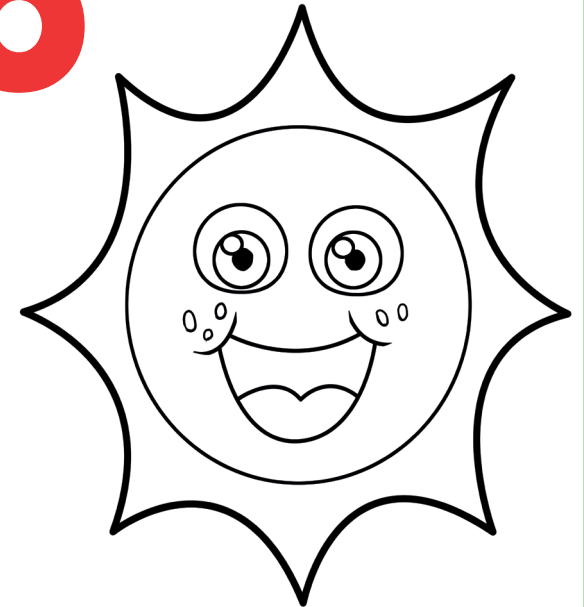

sol

Lee y asocia las
sílabas con la
imagen indicada
de la letra

L - l

le



león

la

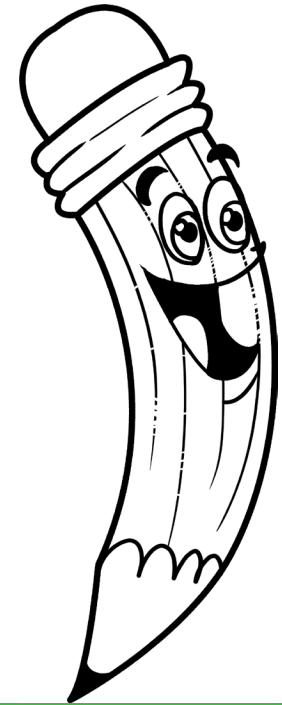

lápiz

li

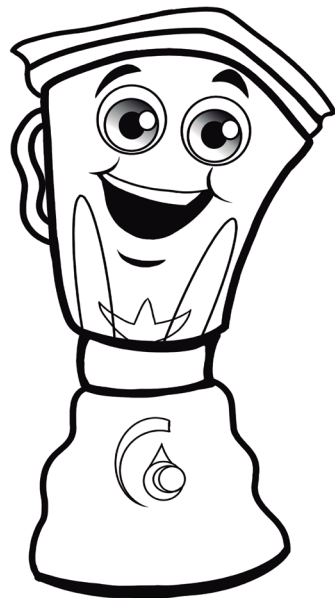

licuadora

lo



loro

lu

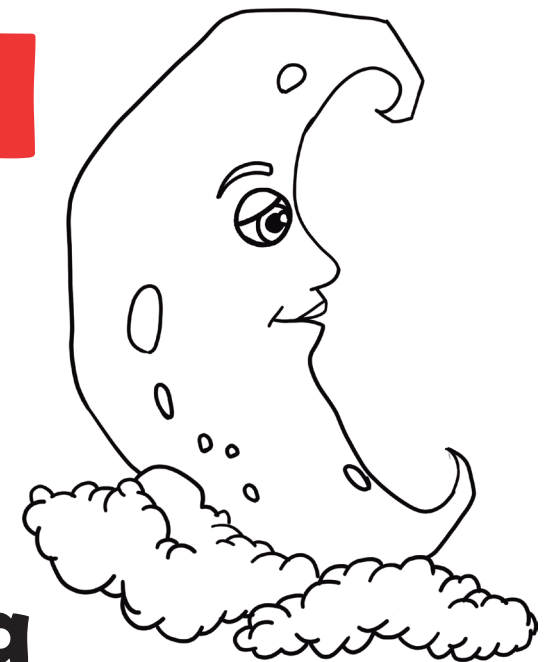

luna

Lee y asocia las sílabas con la imagen indicada de la letra

N - n

no



Noel

nu



nube

na

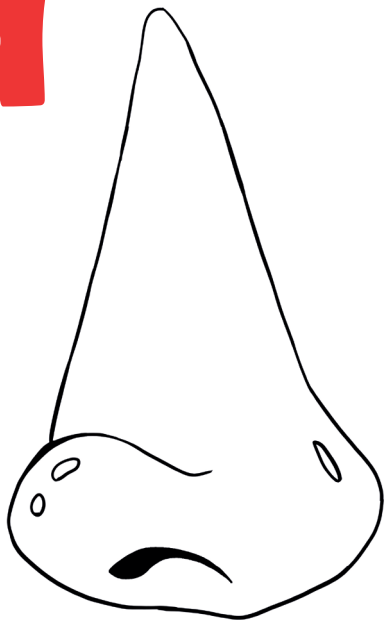

nariz

ni



niños

ne

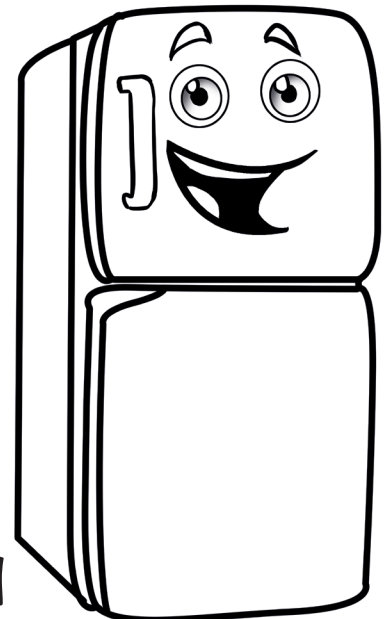

nevera

Lee y asocia las
sílabas con la
imagen indicada
de la letra

T - t

to



toro

ta

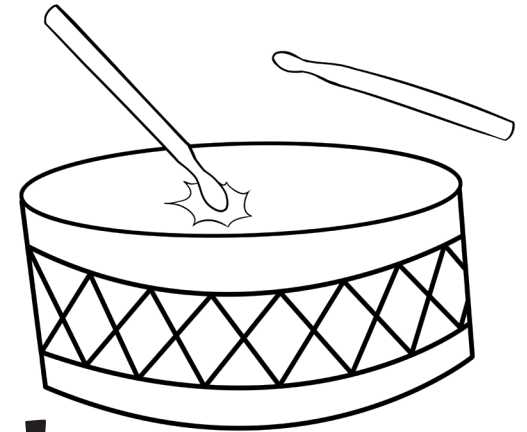

tambor

te

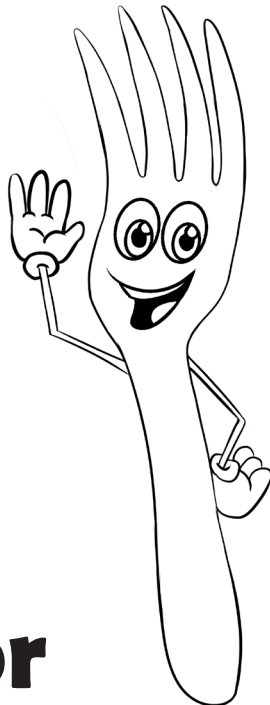

tenedor

tu



tucán

ti



tiburón

Lee y asocia las
sílabas con la
imagen indicada
de la letra

D - d

du



duende

di

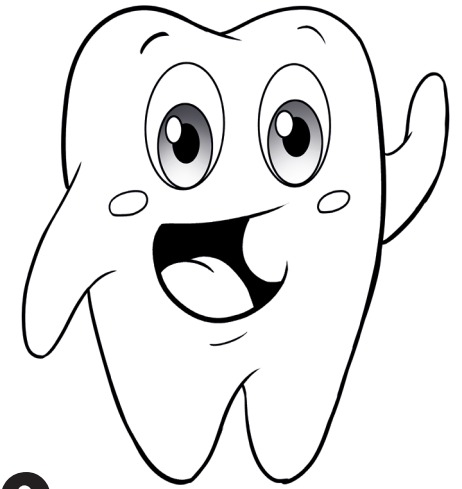

diente

do

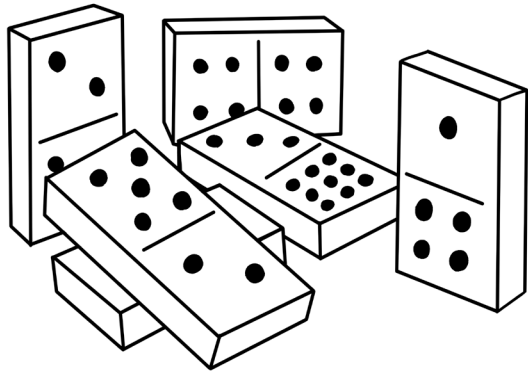

dominó

de

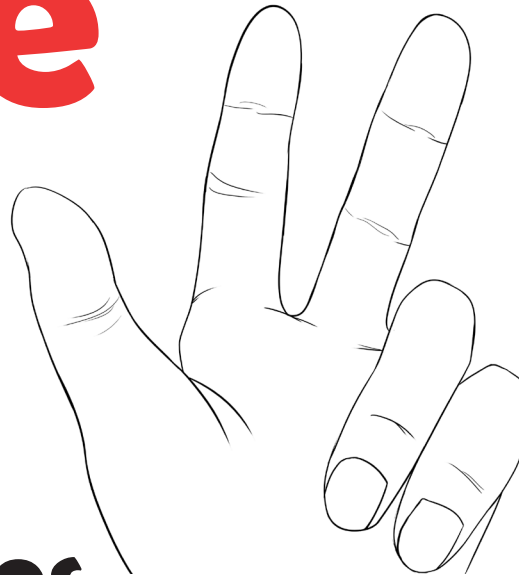

dedos

da

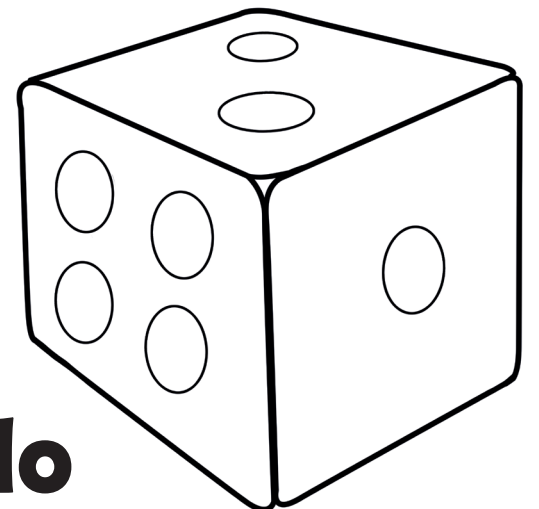

dado

Lee y asocia las
sílabas con la
imagen indicada
de la letra

R - r

ro

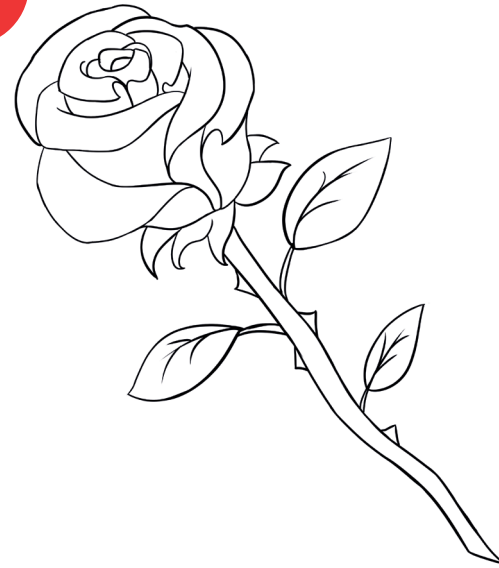

rosa

re

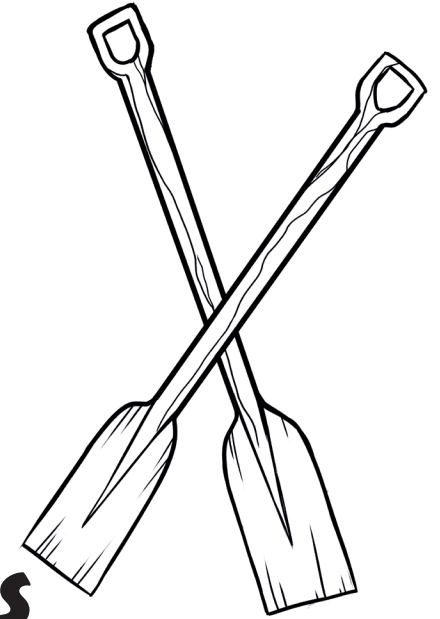

remos

ru

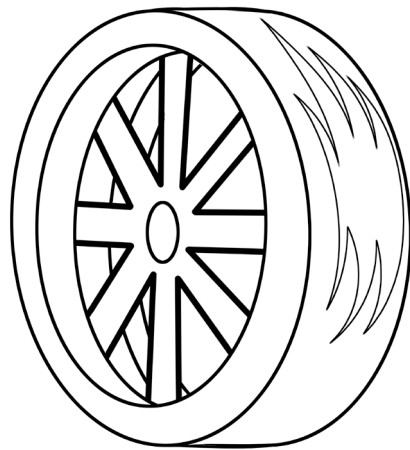

rueda

ra



ratón

ri

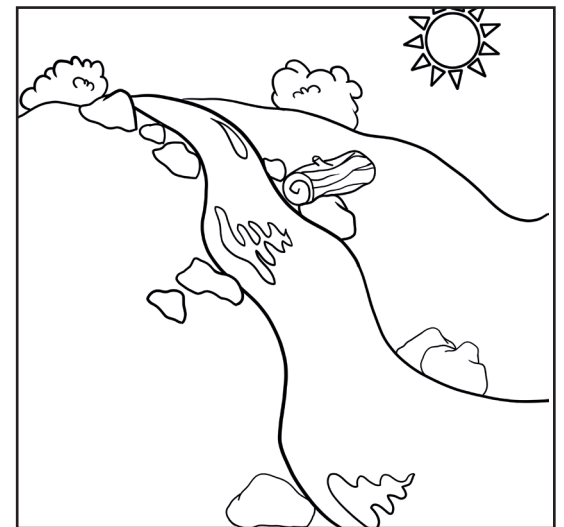

río

Lee y asocia las
sílabas con la
imagen indicada
de la letra

C - c

ca



casa

co

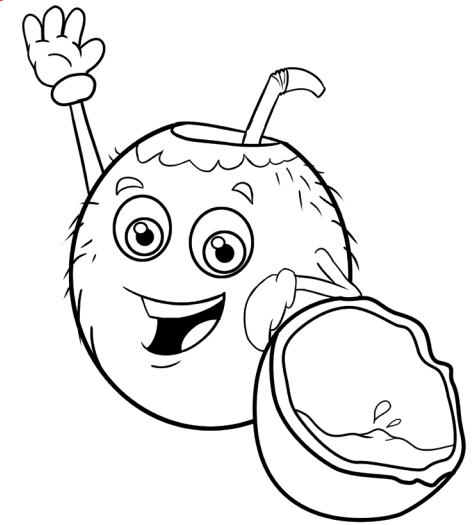

coco

cu



cuna

Lee y asocia las
sílabas con la
imagen indicada
de la letra

Q - q

que

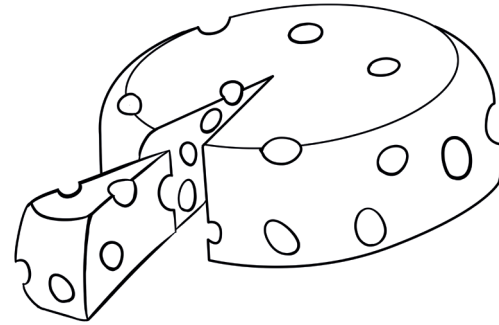

queso

qui



quinientos

Lee y asocia las
sílabas con la
imagen indicada
de la letra

Ñ - **ñ**

ñu

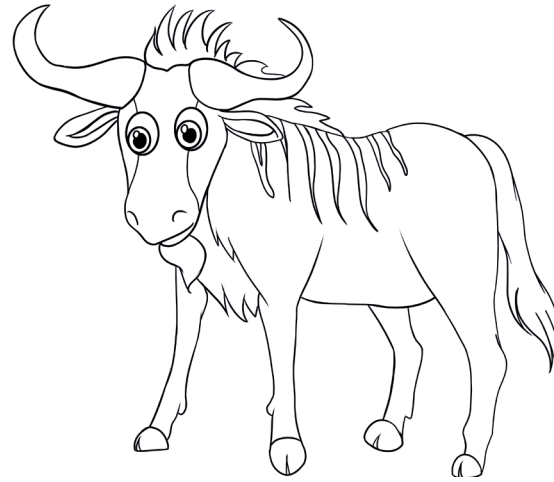

ñu

ña

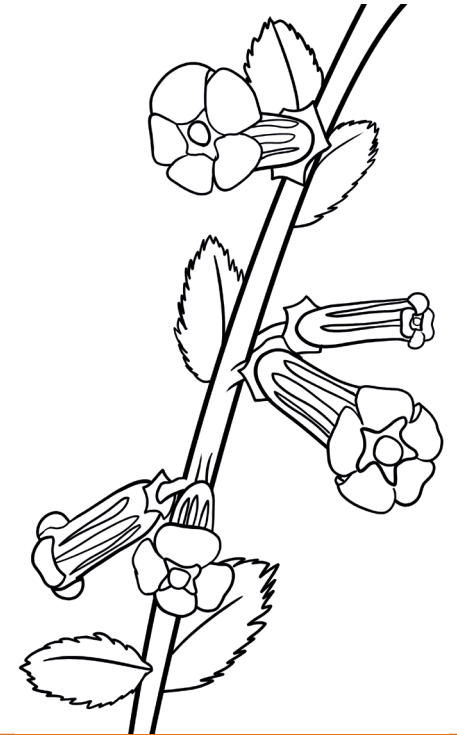

ñaipa

ñe

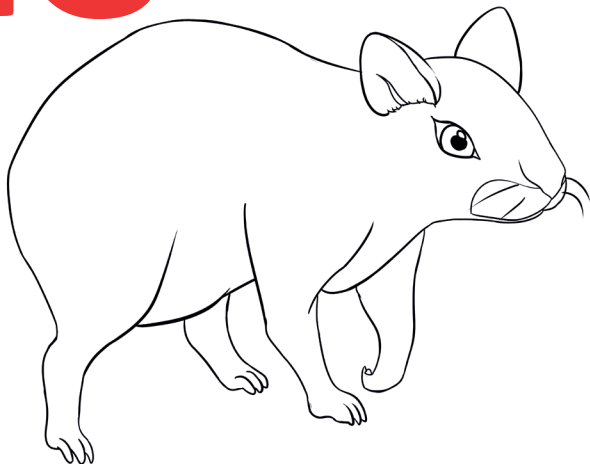

neque

ño



ñora

ña



ñandu

Lee y asocia las
sílabas con la
imagen indicada
de la letra

V - **v**

vo

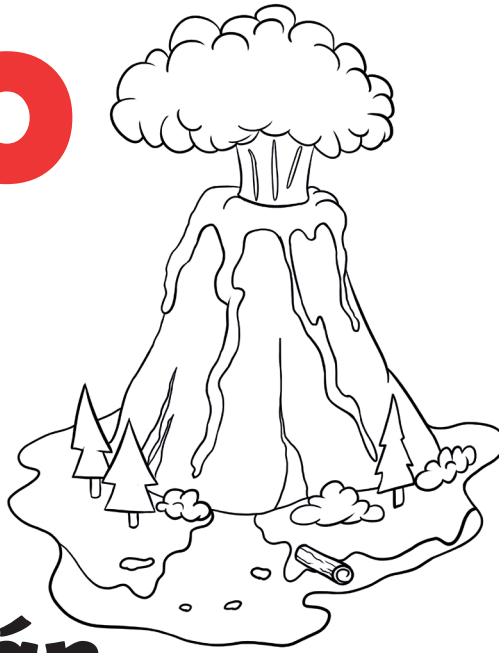

volcán

ve

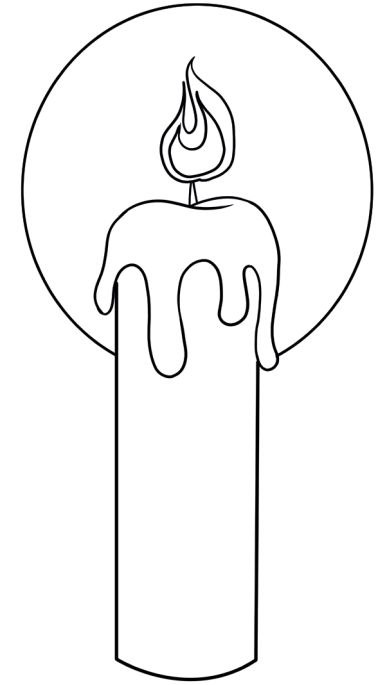

vela

va

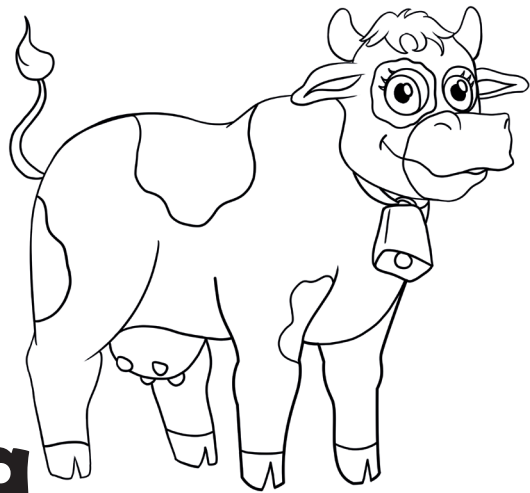

vaca

vi



violín

vu

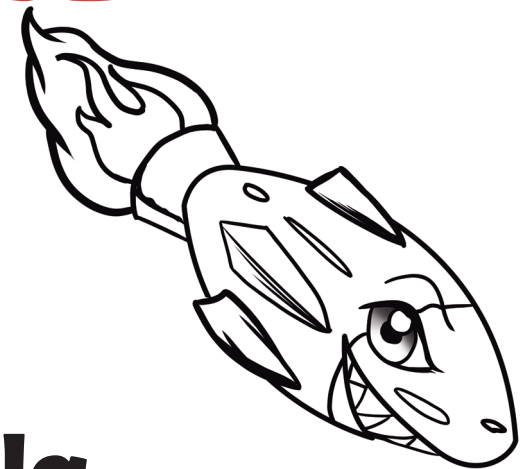

vuela

Lee y asocia las
sílabas con la
imagen indicada
de la letra

B - b

ba

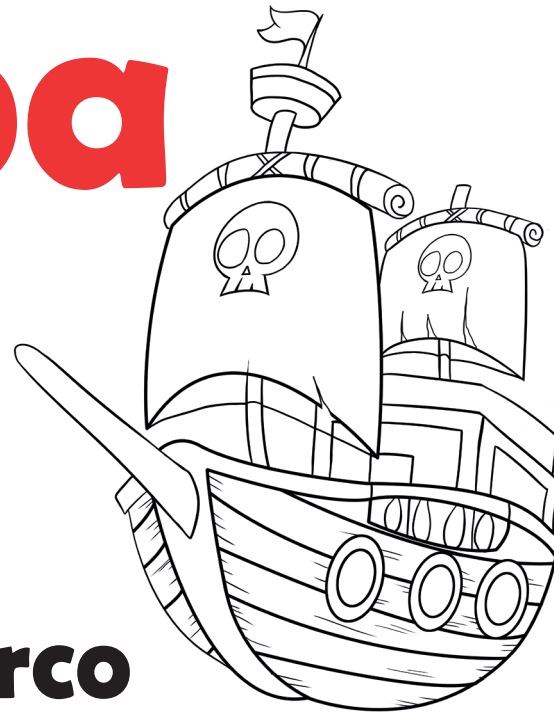

barco

bo



bombero

bi



biberón

bu



burro

be

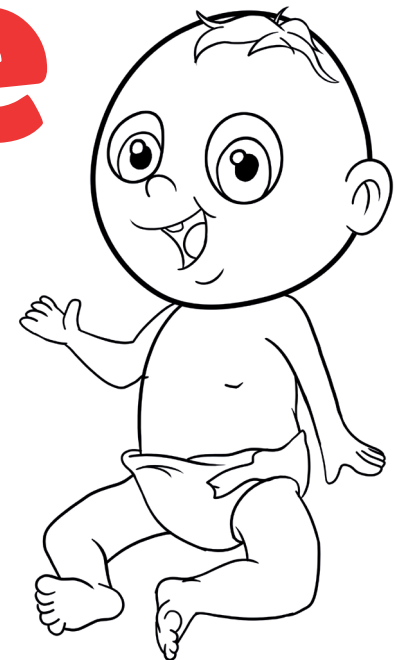

bebé

Lee y asocia las
sílabas con la
imagen indicada
de la letra

G - g

ga

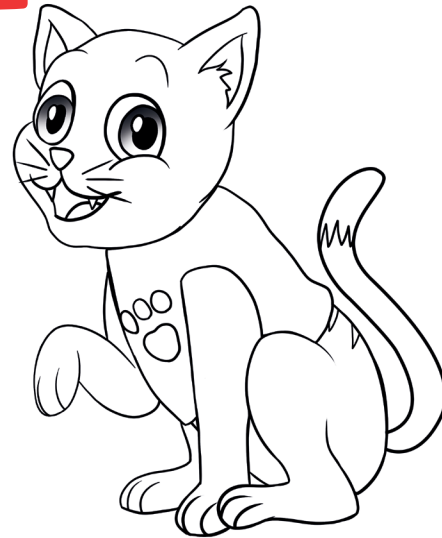

gato

go



gorila

gu

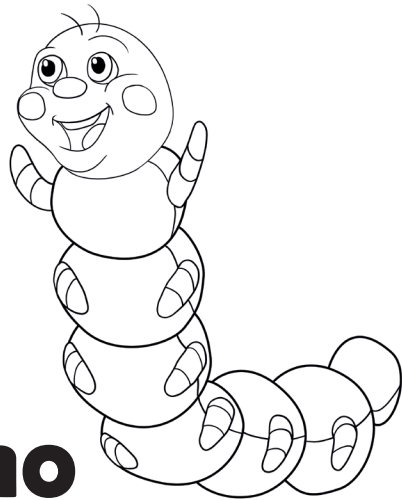

gusano

Lee y asocia las
sílabas con la
imagen indicada
de la letra

Y - y

yo

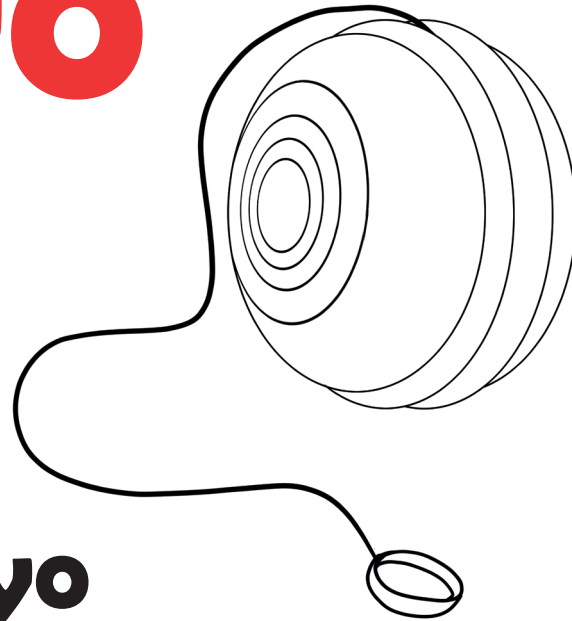

yoyo

ye



yeti

yu

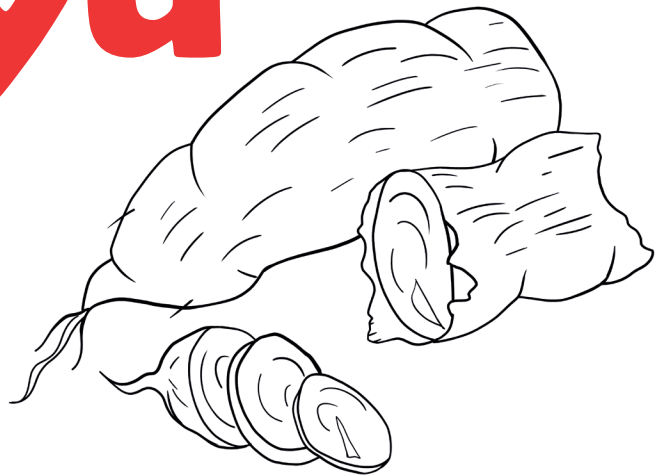

yucas

ya

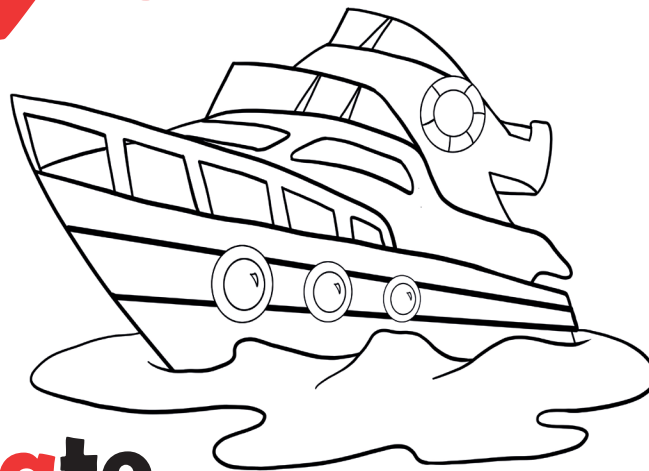

yate

yi

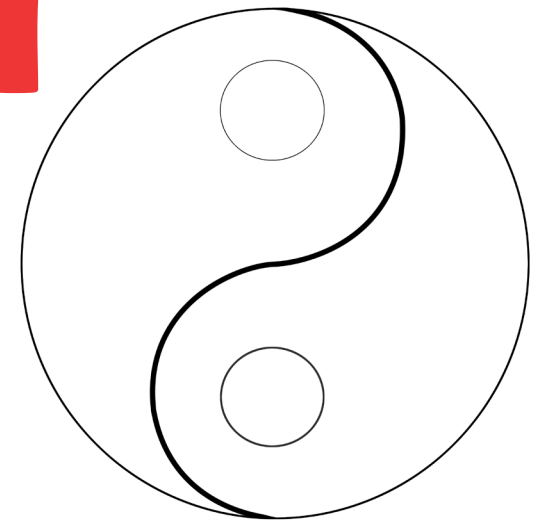

yin yang

Lee y asocia las
sílabas con la
imagen indicada
de la letra

F - f

fo

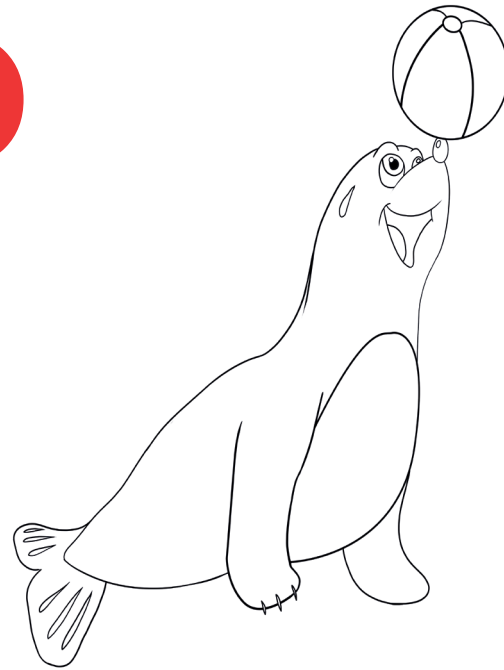

foca

fa



fantasma

fi



fideos

fe



fénix

fu

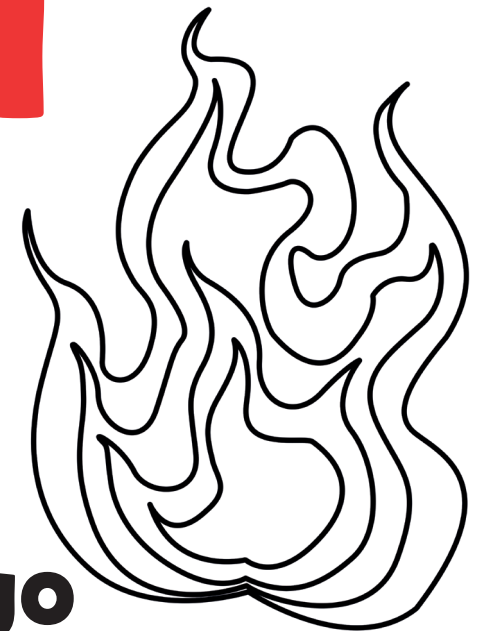

fuego

Lee y asocia las
sílabas con la
imagen indicada
de la letra

H - h

he



helado

hu

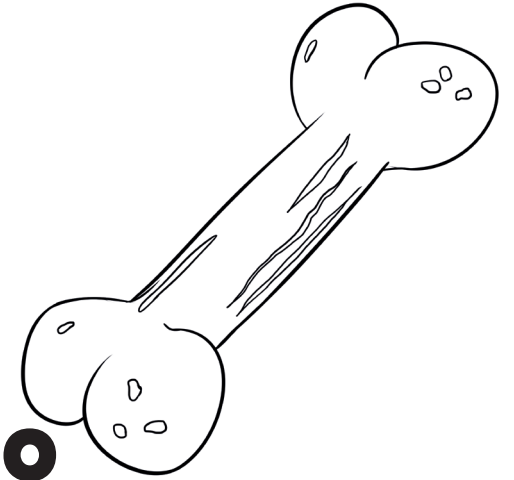

hueso

ho

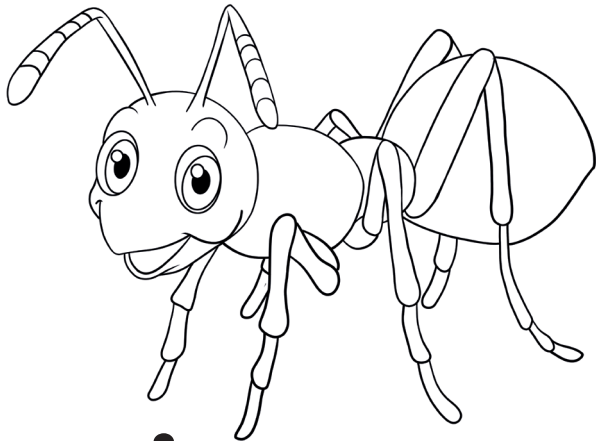

hormiga

hi

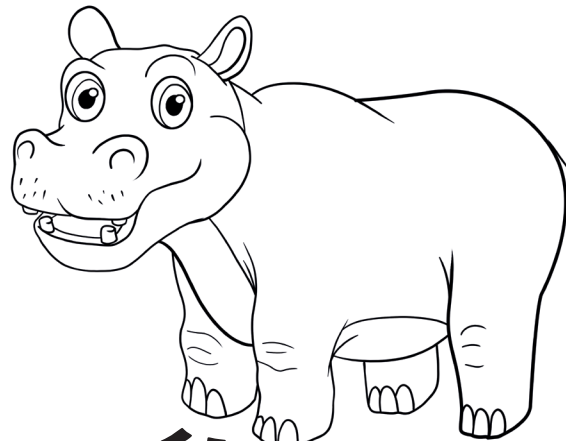

hipopótamo

ha



hada

**Lee y asocia las
sílabas con la
imagen indicada
de la letra**



Lee y asocia las
sílabas con la
imagen indicada
de la letra

J - j

ji



jirafa

je

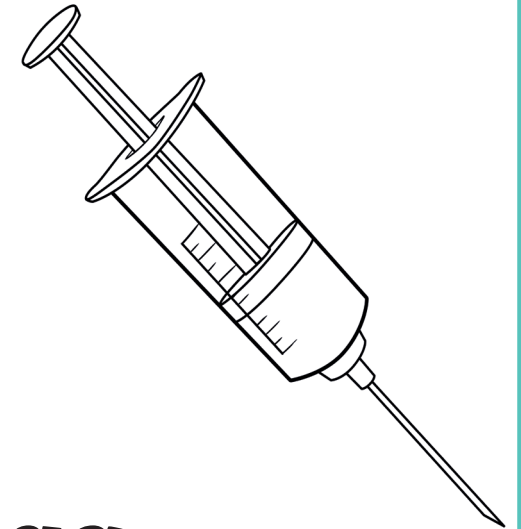

jeringa

ju

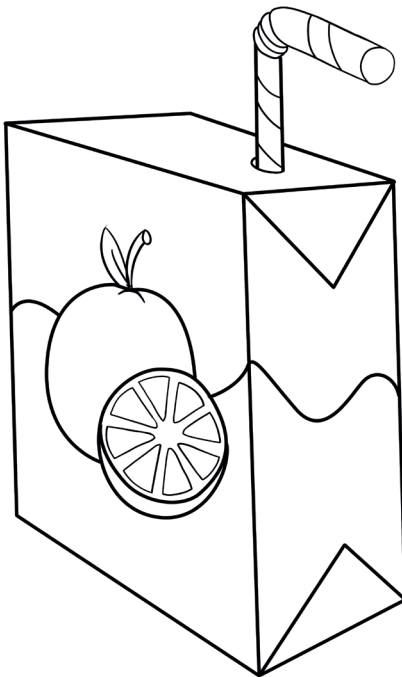

jugo

ja

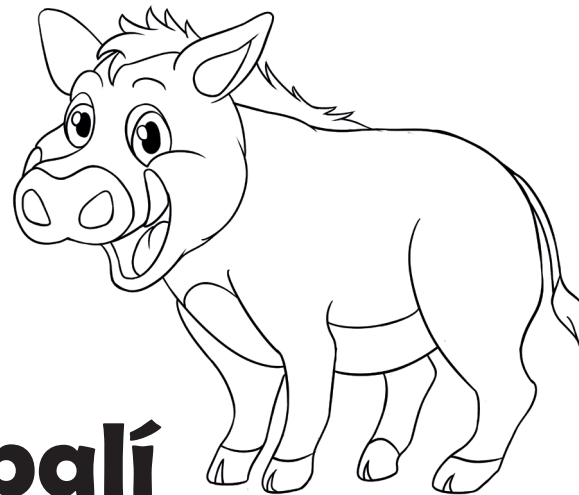

jabalí

jo



joyero

Lee y asocia las
sílabas con la
imagen indicada
de la letra

Z - z

zo



zombie

zu

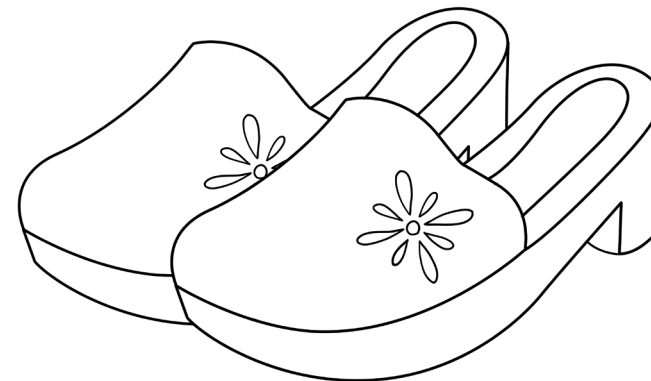

zuecos

za



zapatos

zi

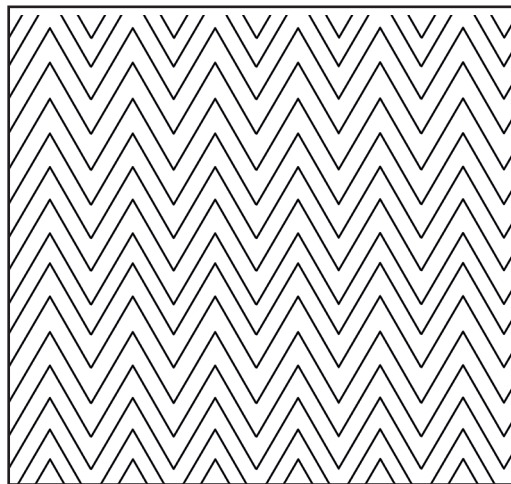

zigzag

ze



Zeus

Lee y asocia las
sílabas con la
imagen indicada
de la letra

Li - ll

lla



llaves

lle



llevar

lli

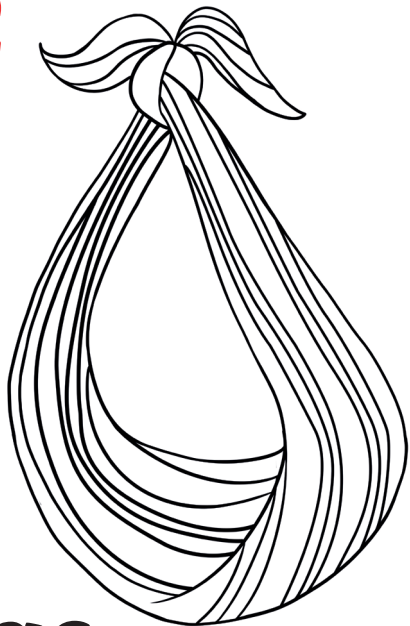

liclacs

llo

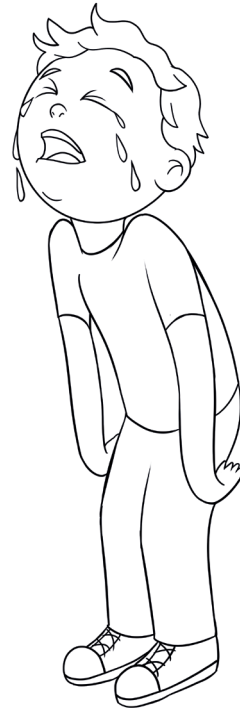

llorar

llu

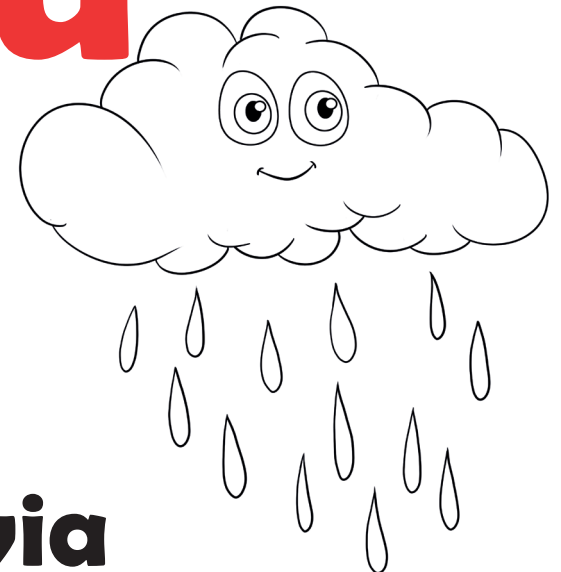

lluvia

Lee y asocia las
sílabas con la
imagen indicada
de la letra

Ch - ch

chi

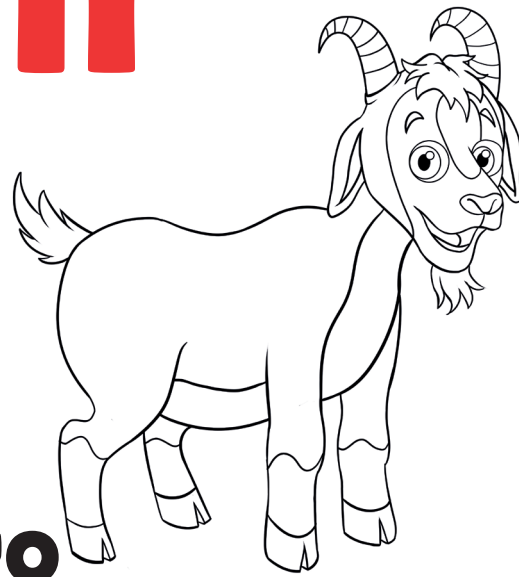

chivo

cha



chaqueta

cho

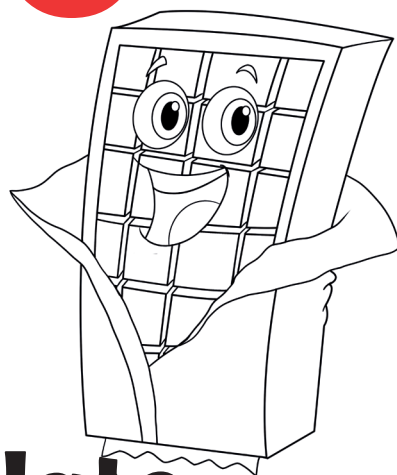

chocolate

che



chef

chu

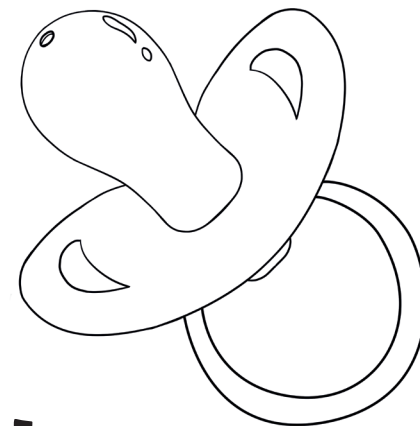

chupete

Lee y asocia las
sílabas con la
imagen indicada
de la letra

Gue - gui

gue

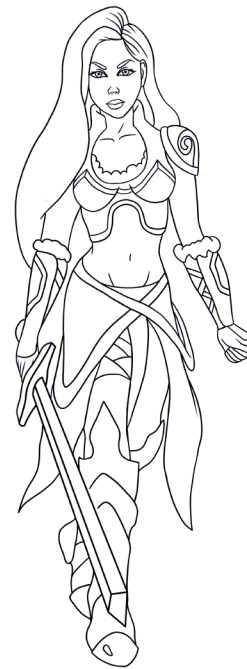

guerrera

gui



guitarra

Lee y asocia las
sílabas con la
imagen indicada
de la letra

Ce - ci

ce

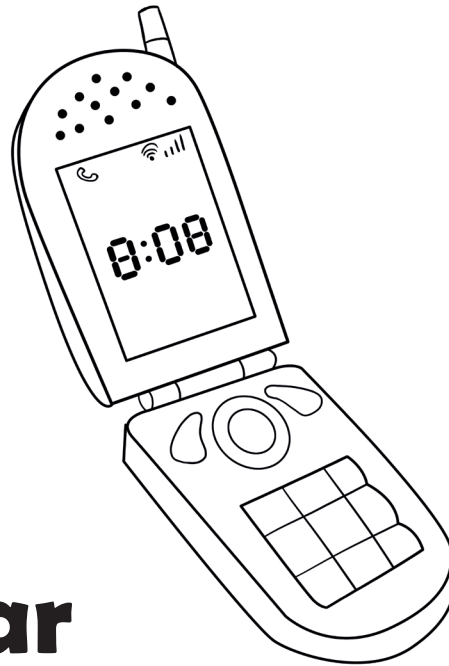

celular

ci

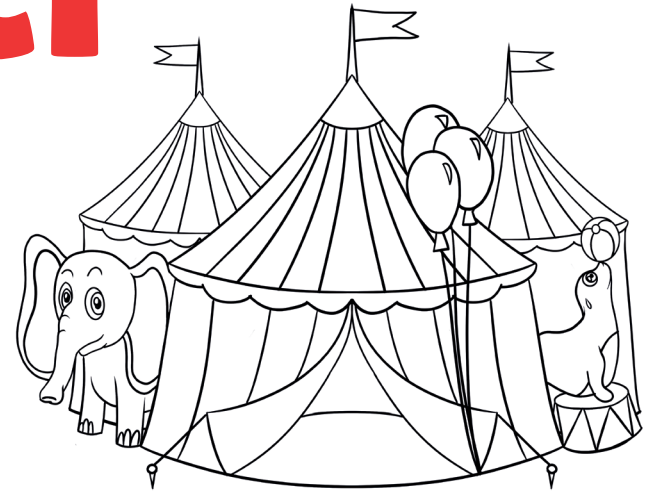

circo

Lee y asocia las
sílabas con la
imagen indicada
de la letra

Ge - gi

ge

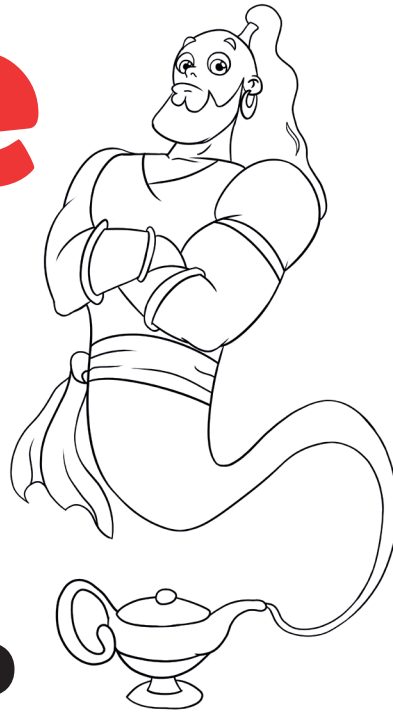

genio

gi

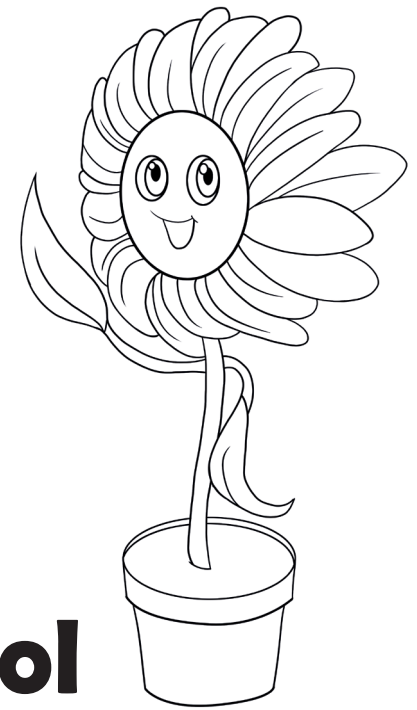

girasol

Lee y asocia las
sílabas con la
imagen indicada
de la letra

W - w

wi



windsurf

wo



wolfman

wa



waterpolo

wu



wushu

we

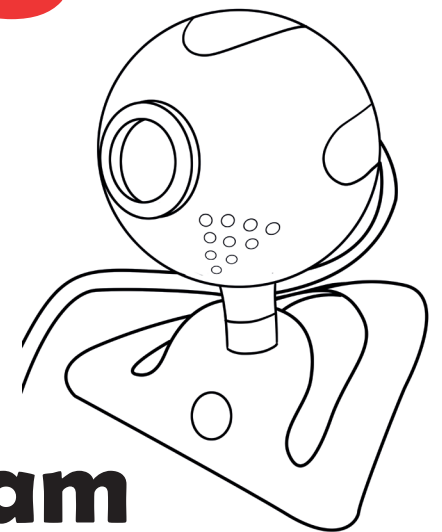

webcam

Lee y asocia las
sílabas con la
imagen indicada
de la letra

K - k

ko

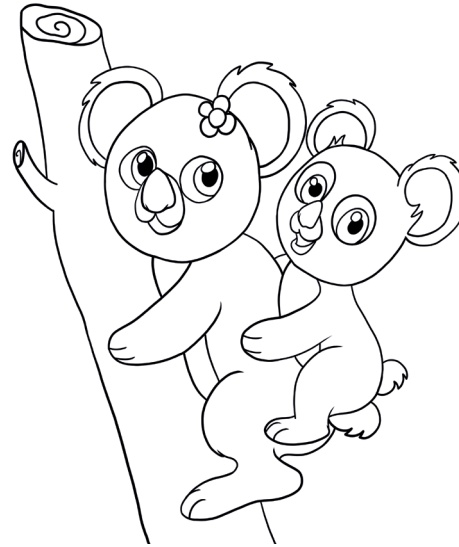

koala

ku

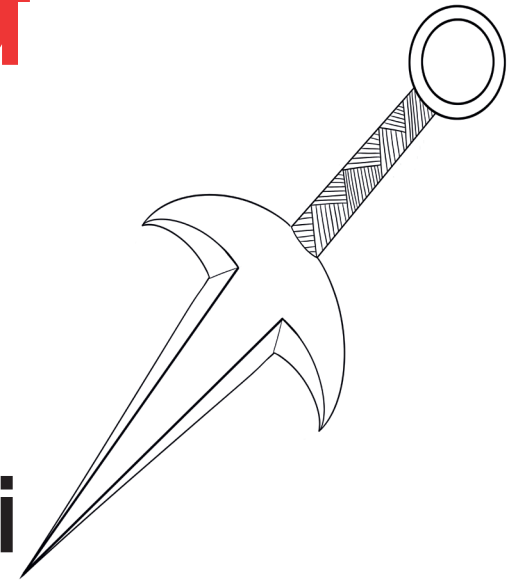

kunai

ka

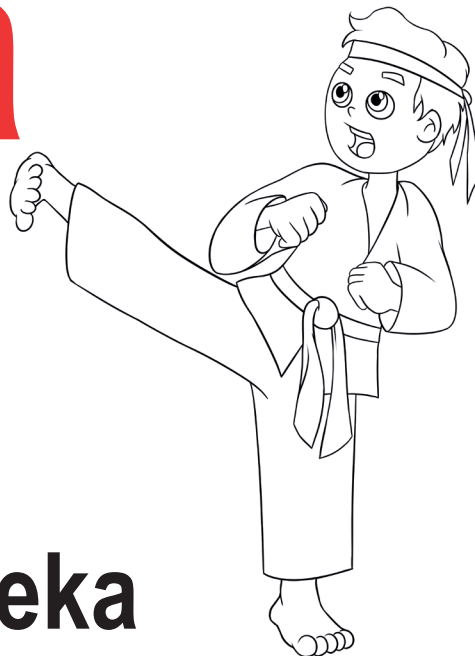

karateka

ke

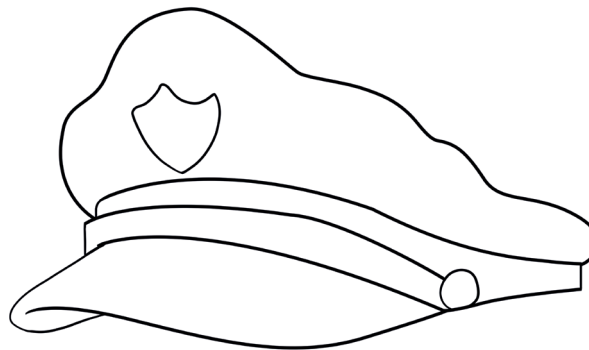

kepis

ki

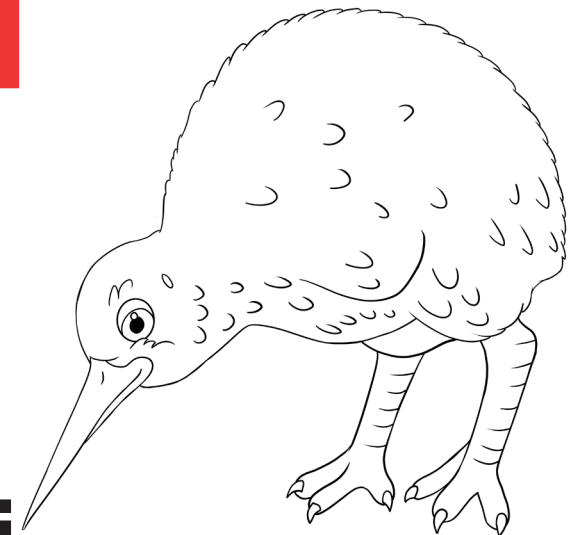

kiwi

Lee y asocia las
sílabas con la
imagen indicada
de la letra

X - x

xi

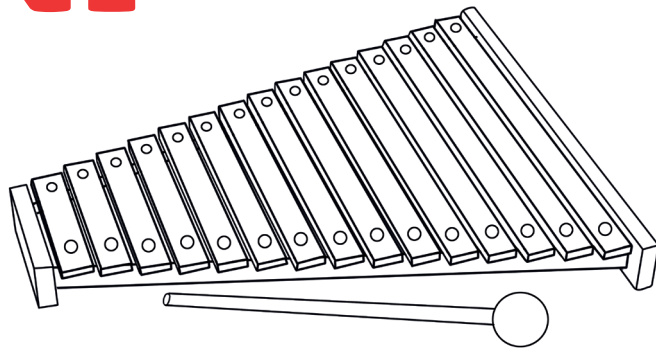

xilófono

xa

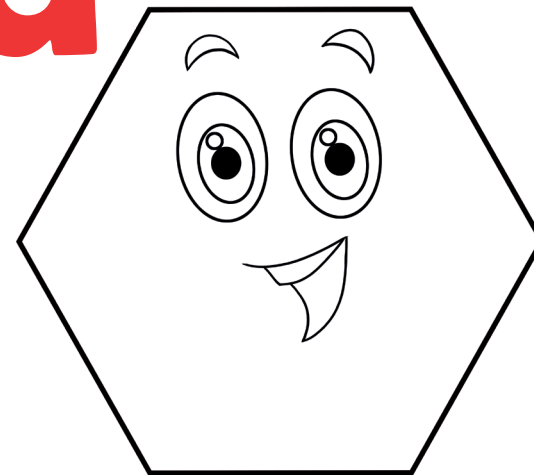

hexá**xa**gono

xo



saxo**fo**n

xe

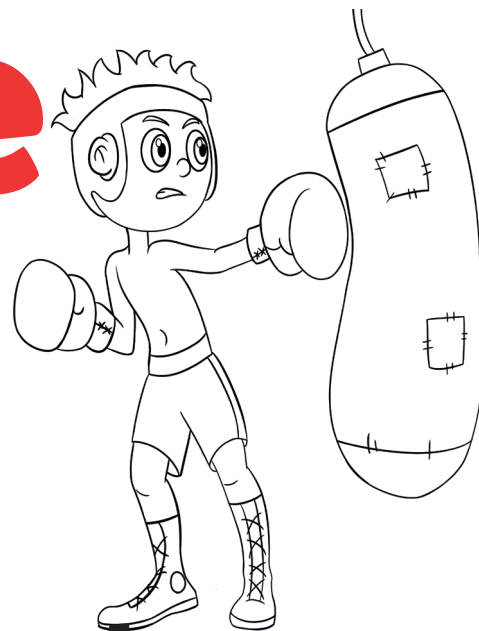

boxeo**xa**dor

Lee y asocia las sílabas con la imagen indicada de la combinación

Pr - pr

pri



princesa

pre

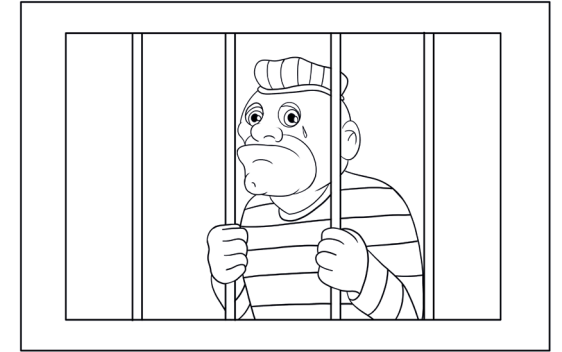

preso

pru

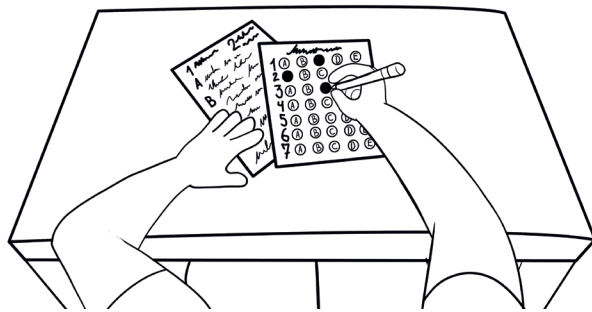

prueba

pra

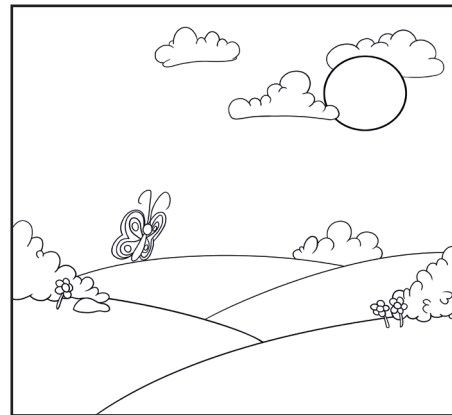

prado

pro

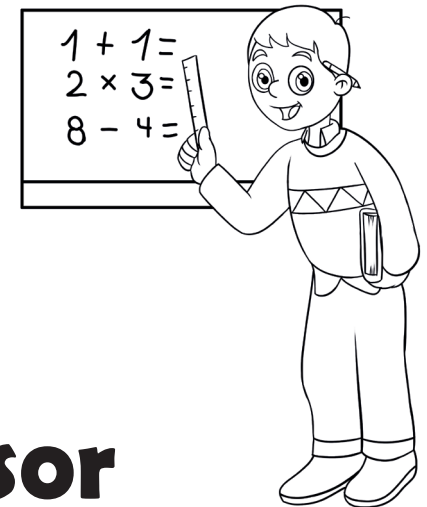

profesor

Lee y asocia las
sílabas con la
imagen indicada
de la combinación

Tr - tr

tre

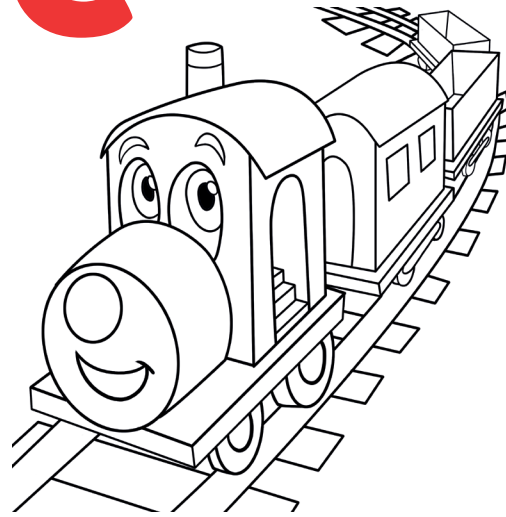

tren

tra



trapero

tri

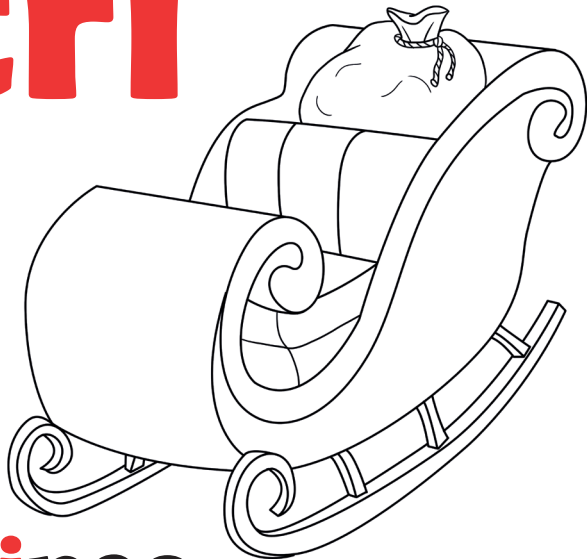

trineo

tru

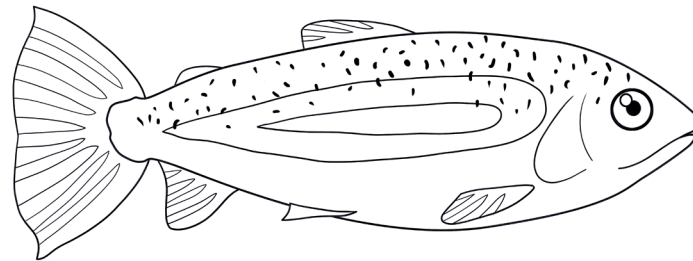

trucha

tro

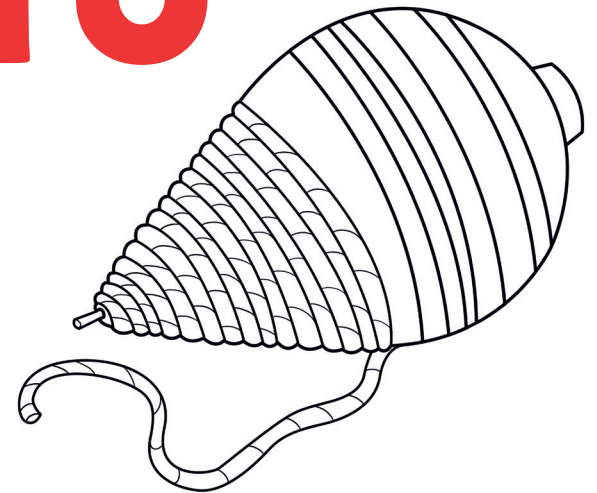

trompo

Lee y asocia las sílabas con la imagen indicada de la combinación

Gr - gr

gru

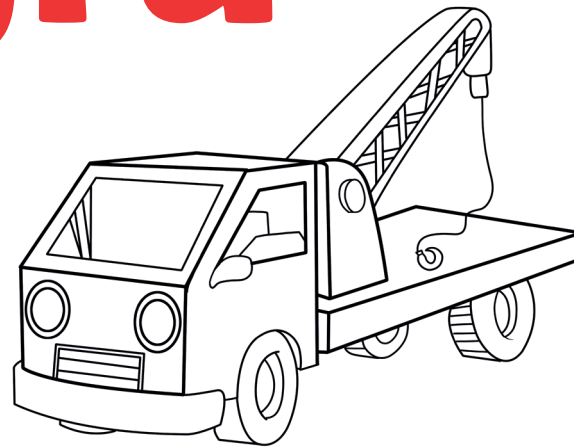

grúa

gra

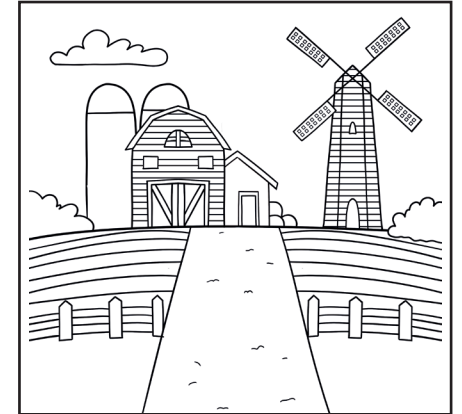

granja

gro

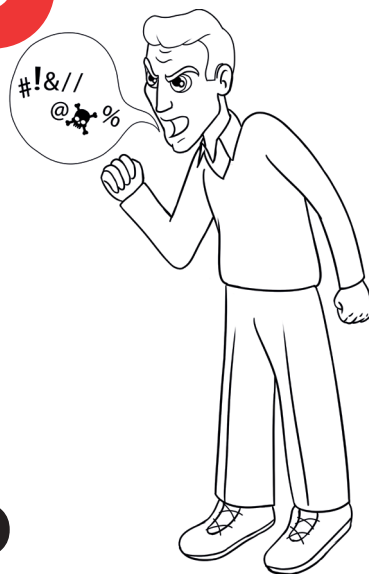

grosero

gri

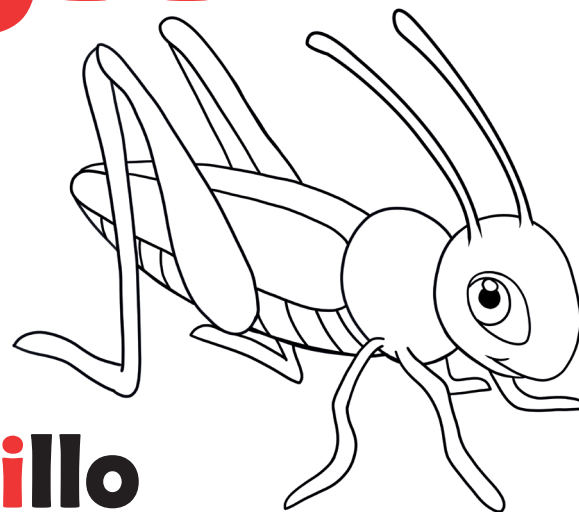

grillo

gre

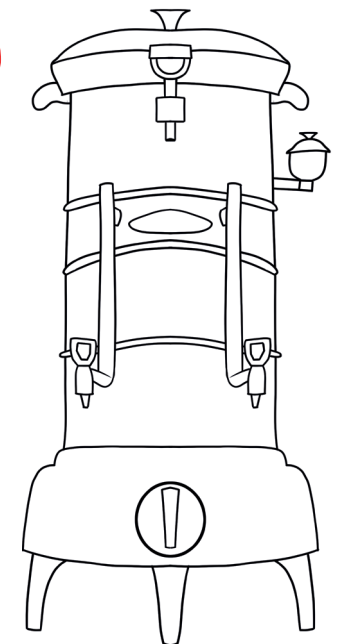

greca

Lee y asocia las sílabas con la imagen indicada de la combinación

Dr - dr

dra



dragón

dro

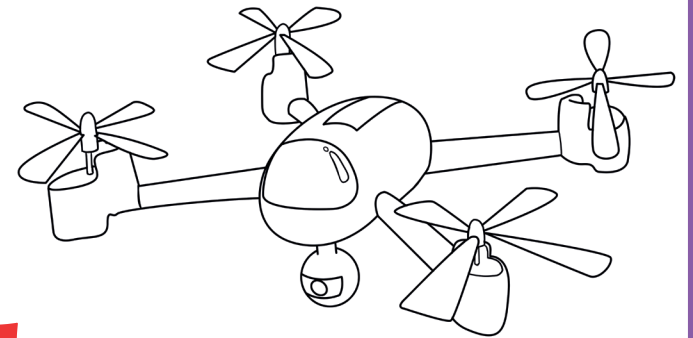

dron

dri



dril

dru



drupa

dre

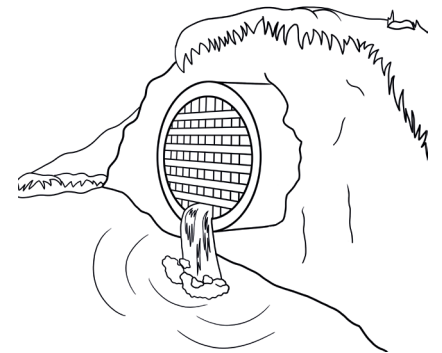

drenaje

Lee y asocia las
sílabas con la
imagen indicada
de la combinación

Br - br

bru



bruja

bri

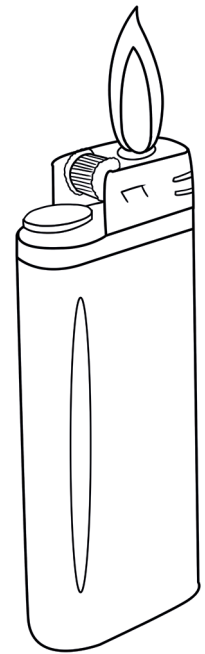

briquet

bra



brazo

bro

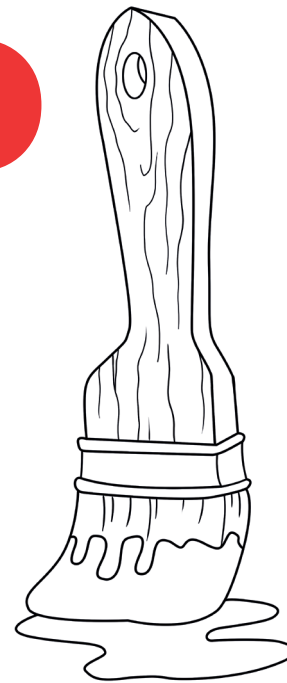

brocha

bre

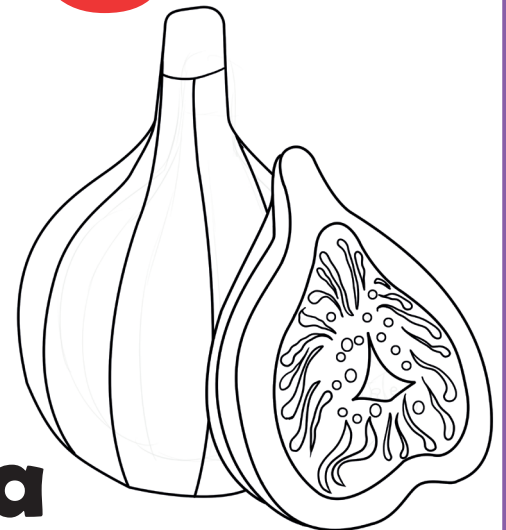

brev

Lee y asocia las sílabas con la imagen indicada de la combinación

Fr - fr

fru



frutero

fra



fragata

fro



frotar

fre

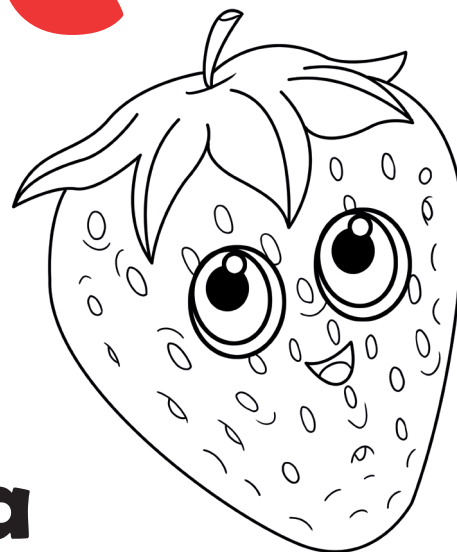

fresa

fri

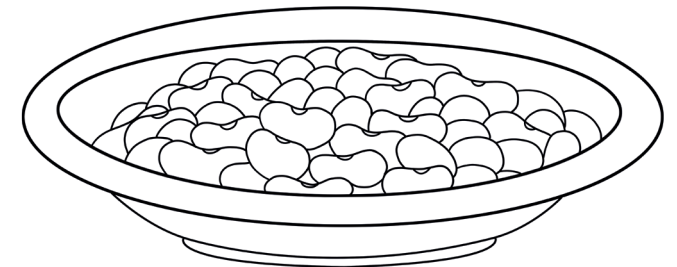

fríjoles

Lee y asocia las sílabas con la imagen indicada de la combinación

Cr - cr

cru



cruz

cri



Cristo

cro

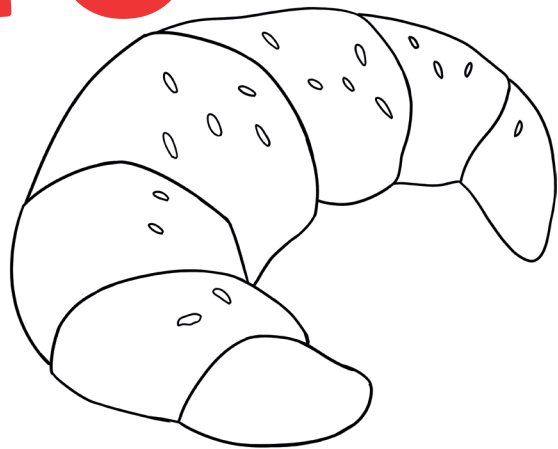

croissant

cre

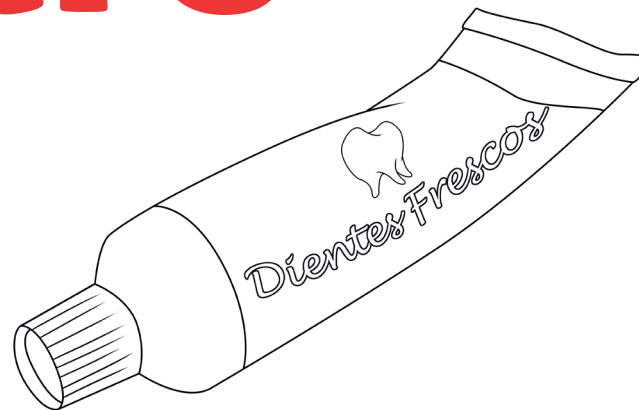

crema

cra

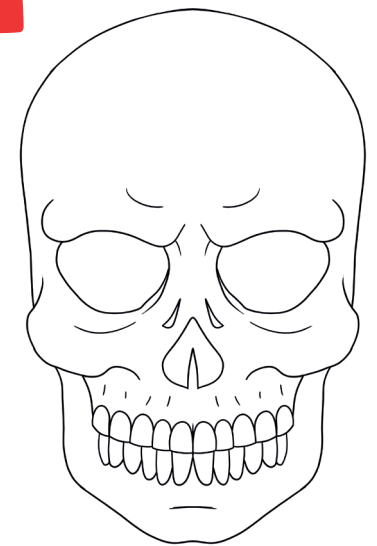

cráneo

Lee y asocia las
sílabas con la
imagen indicada
de la combinación

PI - pl

pla



planeta

pli

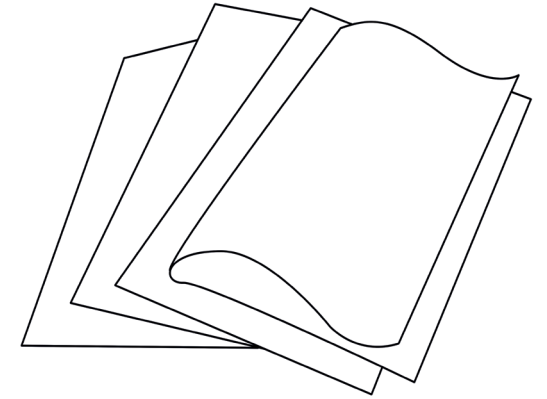

pliegos

plu



plumas

plo



plomero

ple

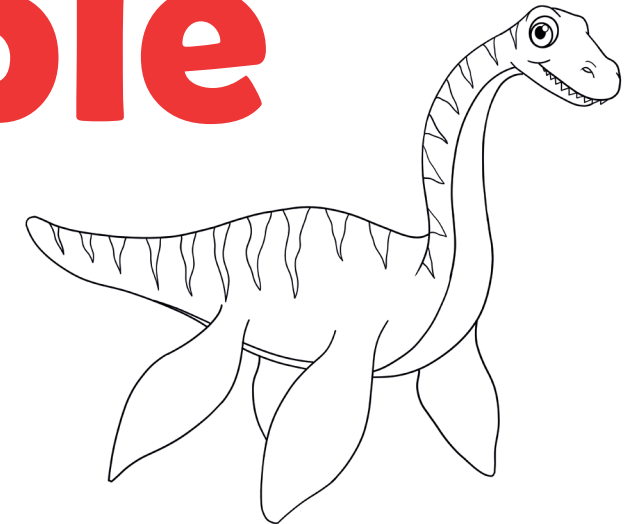

plesiosaurio

Lee y asocia las sílabas con la imagen indicada de la combinación

Cl - cl

clu

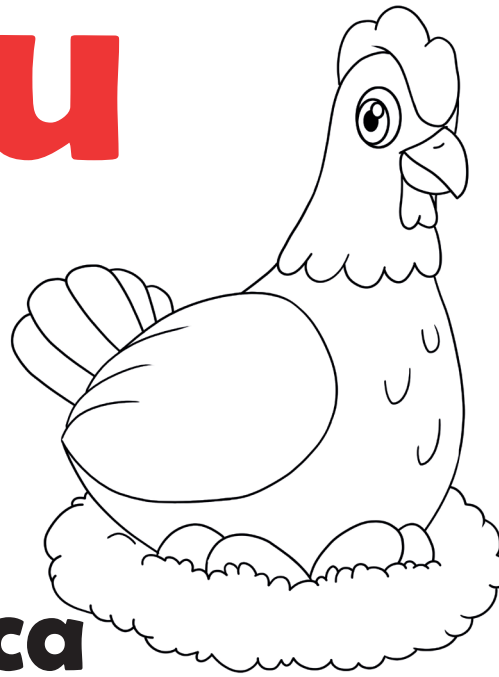

clueca

cla

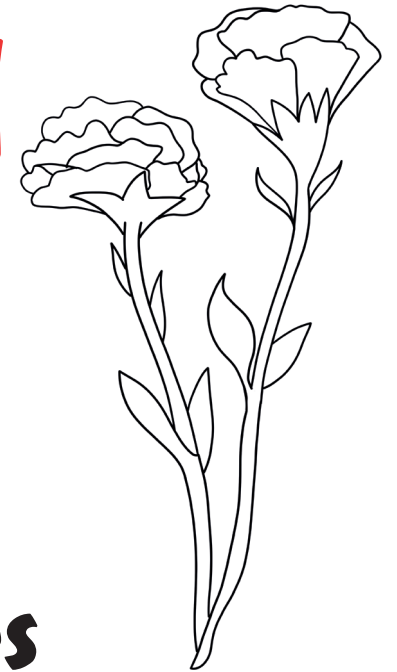

claveles

cle

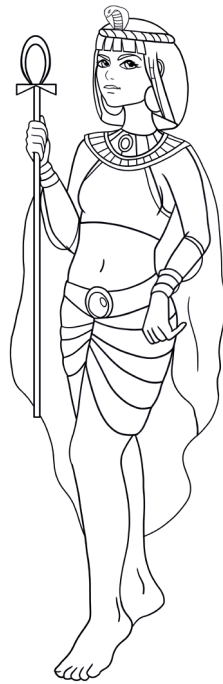

Cleopatra

cli

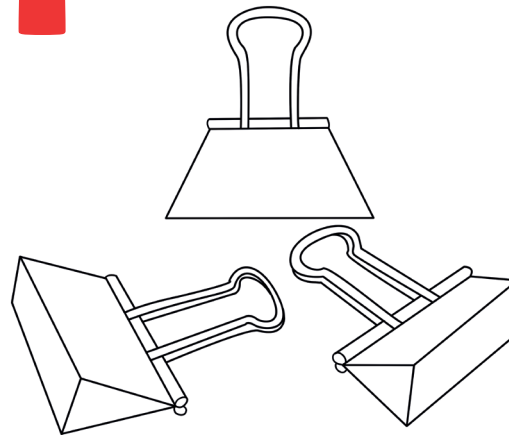

clips

clo



closet

Lee y asocia las
sílabas con la
imagen indicada
de la combinación

Bl - bl

blu



blusa

ble

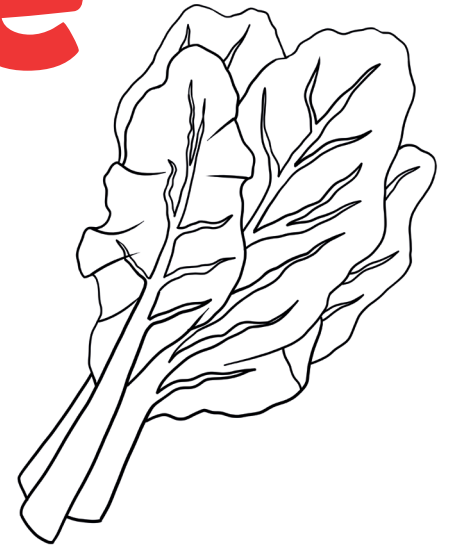

bleda

blo

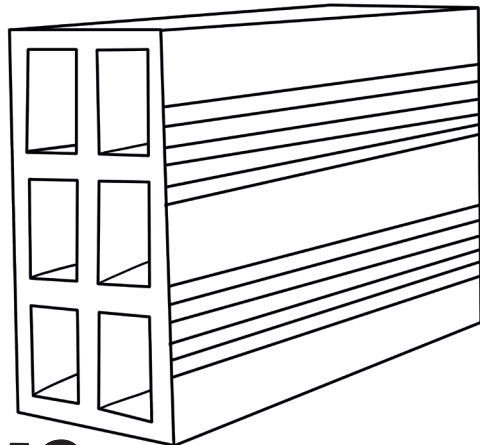

bloque

bla



blanco

bli



blindado

Lee y asocia las sílabas con la imagen indicada de la combinación

Gl - gl

glo



globos

glu

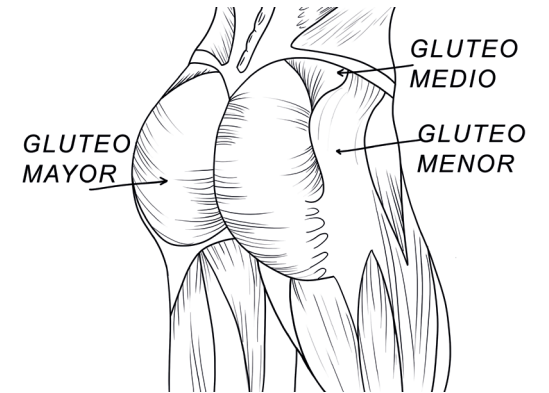

glúteos

gle

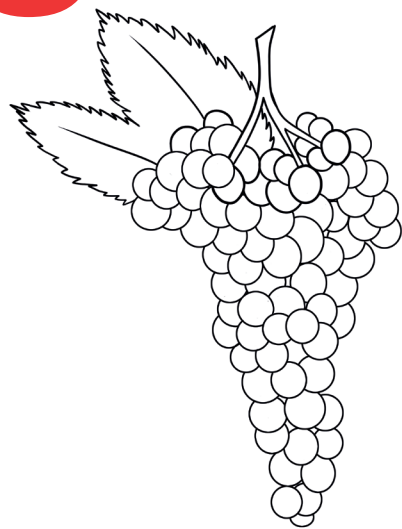

glera

gli



glifo

gla

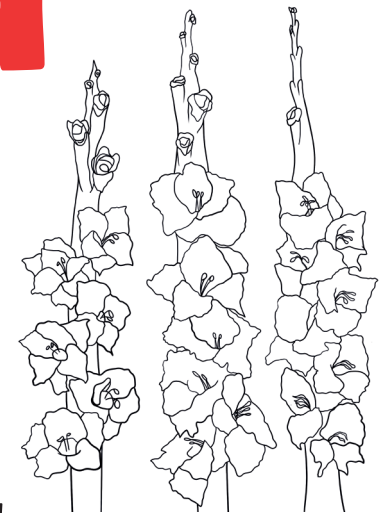

gladiolos

Lee y asocia las
sílabas con la
imagen indicada
de la combinación

Fl - fl

flo

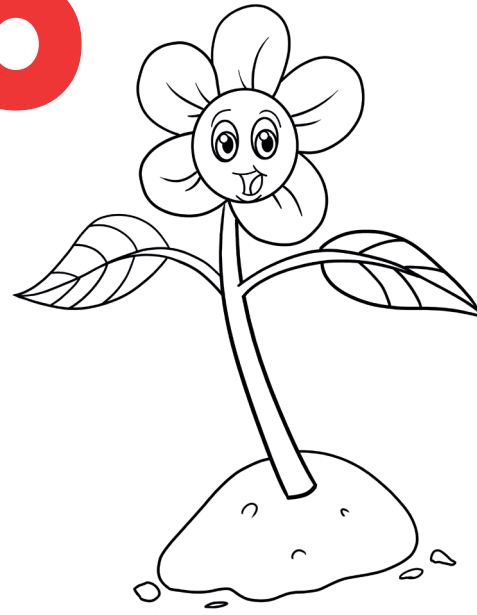

flor

fla

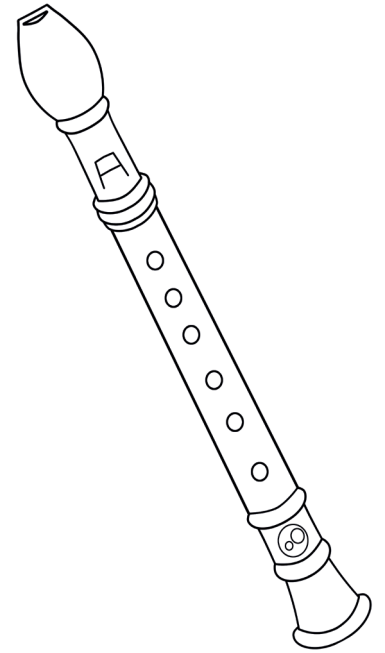

flauta

flu

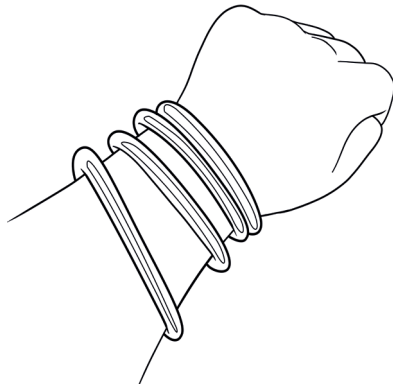

fluorescente

fle

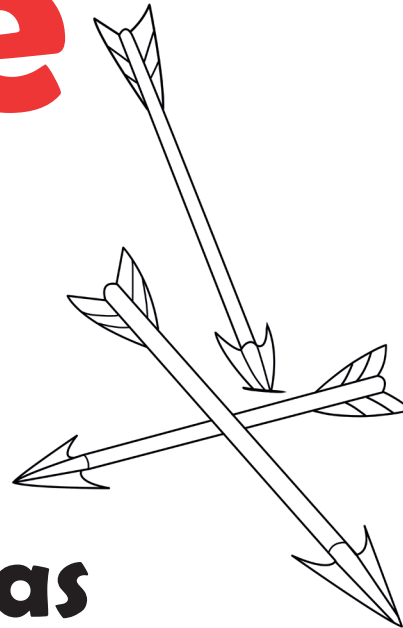

flechas

fli

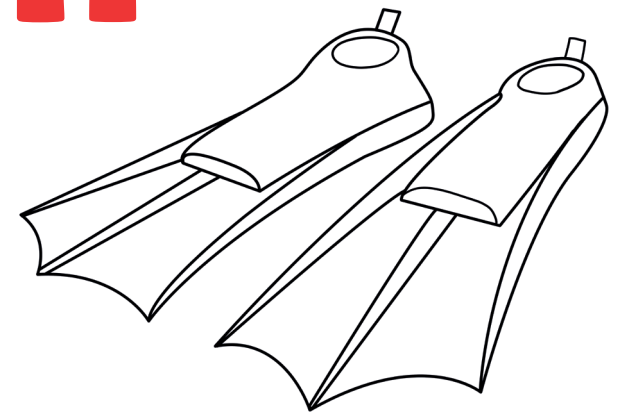

flippers